

R420 Shown

**MODEL NUMBER:**

- R420 Two-Way In-Wall Diverter**  
1/2" NPT inlets/outlets. Less Handle.
- R430 Three-Way In-Wall Diverter**  
1/2" NPT inlets/outlets. Less Handle.

**NOTE:** Cannot be used as a shut-off valve.

**ALL CONNECTIONS 1/2" NPT**

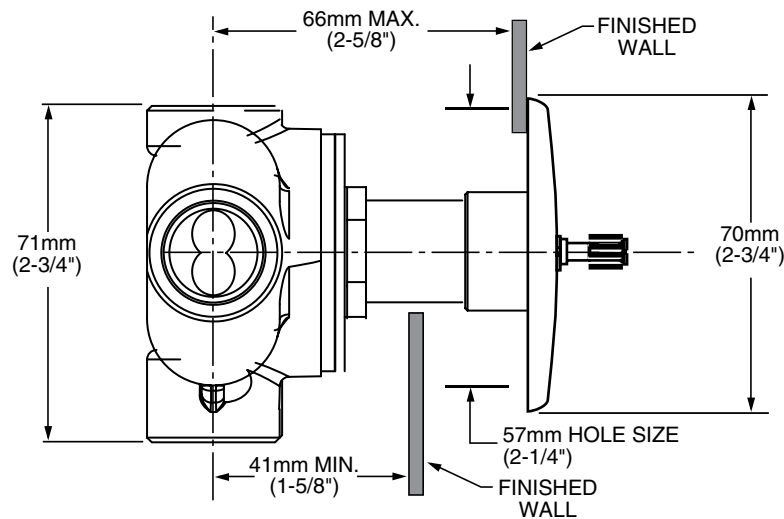

**GENERAL DESCRIPTION:**

In-Wall Diverter: Rotational control alternates water flow between two (R420) or three (R430) different shower outlets (i.e. showerhead, handspray, body side spray or tub spout). Forged brass valve body. Mixed water inlet and two (R420) or three (R430) outlets are marked on back of valve body. 1/2" NPT connections on mixed water inlet and two (R420) or three (R430) outlets. Stamped brass escutcheon. Tub port with increased water flow (see chart).

**NOTE:** Cannot be used as a shut-off valve.

**PRODUCT FEATURES:**

**Solid Brass Construction:** Durable, ideal material for prolonged contact with water.

**Removable Plaster Guard:** Permits checking of valve installation prior to installing trim parts.

**Choice of Finishes:** Wide range of durable finishes.

**SUGGESTED SPECIFICATION**

Two (three) way diverter shall feature a forged brass body with 1/2" NPT mixed water inlet and outlets. Fitting shall be American Standard Model # R4\_0.

**CODES AND STANDARDS**

These products meet or exceed the following codes and standards:

**ASME A112.18.1  
CSA B125.1**



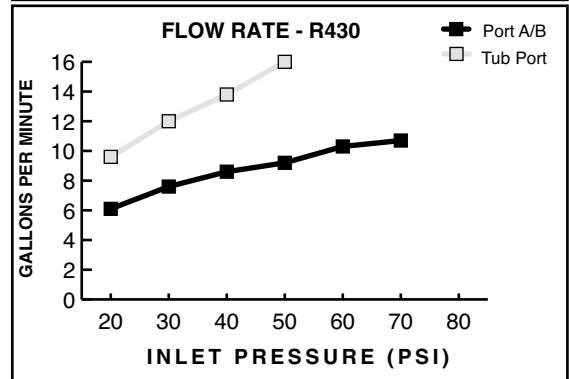
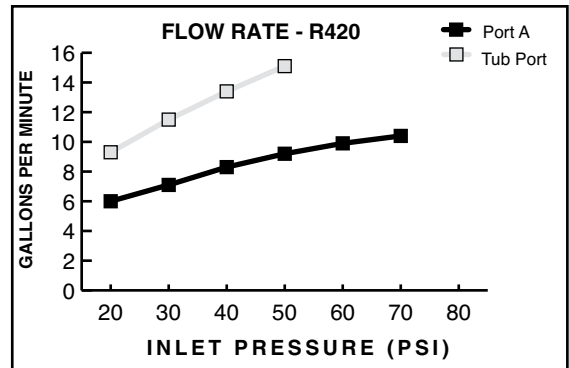





















 Meets the American Disabilities Act Guidelines and **ANSI A117.1** Requirements for the physically challenged.

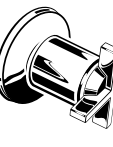

ROUGH VALVE BODIES	Product Number	Description
	R420*	Two-Way In-Wall Diverter. 1/2" NPT inlets/outlets. Less Handle.
	R430*	Three-Way In-Wall Diverter. 1/2" NPT inlets/outlets. Less Handle.

\* Rough and Trim must be ordered separately.

R420 and R430 will accept the following handles:

AVAILABLE TRIM KITS	Enfield® Lever	Enfield Cross	Ceratherm™ II	Town Square®	Amarilis®-Series:		
							
	T373.430 	T373.432 	T203.430 	T555.430 	T001.441 	T001.431 	T001.541 
Serin™	Green Tea®	Copeland™	Moments™	Berwick™	Berwick		
							
T064.430 	T010.430 	T005.430 	T506.430 	T430.430 	T430.432 